



Food Preparation Machines
Made in Sweden

RG-50 Vegetable Preparation Machine

- Slices, dices, shreds, grates, makes julienne and crimping slices.
- Processes fruit, vegetables, dry bread, cheese, nuts, mushrooms, etc.
- Table top machine made for smaller kitchens.
- Processes up to 80 portions/day and 2 kg/minute.



Vegetable Preparation Machine

RG-50



Ergonomics in all stages

RG-50 is the most compact vegetable preparation machine from HALLDE. It is developed to suite smaller kitchens and the compact design makes RG-50 easy to put away and bring back when needed. The machine is a table top and can be used directly on the kitchen workbench. RG-50 pusher plate is swung up in a bow shape angle. This together with the low height makes for a better working posture.

Safe and quick top ups

Thanks to the automatic start and stop function the machine stops as soon as the pusher plate is swung up. When it is swung back the machine restarts and you can continue working. A clear advantage, particularly when larger volumes are involved.

Double safety against unprotected blades

If the feed cylinder is removed the power is cut. Thanks to this double security there is no risk of the machine starting with an unprotected blade.

Developed for the best hygiene

The RG-50 is manufactured solely from hygiene certified material. The machine has smooth surfaces, rounded edges and has no unnecessary recesses where food might penetrate and get stuck.

Easy cleaning

For quick cleaning are all loose parts simple to remove for easy rinsing of the machine. The feed cylinder is removable and can be washed in a dishwasher.

Only the best material

The machine base is made of robust metal, the feed cylinder and pusher plate are made of strong polycarbonate. Only top quality stainless steel is used to manufacture the cutting tool knife blades.

Lightweight and easy to move

The small size of the machine gives several advantages. It does not take up a lot of space in the kitchen. And it is easy to move, something which is helped by the generously sized handles on the sides.



Highest possible reliability

The powerful motor has a high starting and running torque and powers the cutting tool via a self tensioning belt. The motor speed is geared down which makes the RG-50 an exceptionally reliable machine – irrespective of the products you are preparing.

Cutting tools with complete register

Our wide range of cutting tools means the RG-50 can handle every conceivable task. You choose the cutting tool you need to make you even more efficient in the kitchen. The RG-50 slices, dices, shreds, grates, makes juliennes and crimping slices – everything from firm to soft products. The blades and grating plates are replaceable. As a result you do not need to buy new cutting tools.



Always perfect cutting results

The rotation speed of the cutting tools is optimised for cutting fine and even slices as efficiently as possible. The blades are purposely sharpened to avoid inertia or the edge breaking off.



RG-50 Accessories



3-pack Cutting Tools



Knife Guard



Wall Rack



Brush

Top quality cutting tools for any cut and optimal results



Standard Slicer

8, 10 mm.

- Slices firm products such as root vegetables.

- Dices in combination with a suitable dicing grid.



Fine Cut Slicer

1, 1.5, 2, 4, 5, 6, 7, 9, 15 mm.

- Slices firm and soft products, such as root vegetables, bell pepper, onion, leek, cucumber, tomato, apple, citrus fruit, bananas, mushrooms, etc.

- Shreds lettuce and cabbage.
- Chops onions in combination with dicing grid.
- Dices in combination with suitable dicing grid.



Crimping Slicer

4-5 mm.

- For ripple slicing of beetroot, cucumber, carrots, etc.



Julienne Cutter

2X2, 2.5X2.5, 4.5X4.5, 6X6, 8X8, 10X10 mm.

- Makes julienne potatoes and carrots for soups, cucumber for sallads, etc.

- Julienne potatoes to curved French fries.

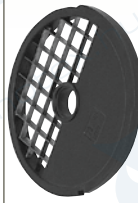

Dicing Grid

7.5X7.5, 10X10, 12.5X12.5, 15X15, 20X20 mm.

- Dices root vegetables, fruit, potatoes, cabbage, swedes, carrots, cucumbers, apples, etc. in combination with a suitable standard slicer or fine cut slicer.



Grater/Shredder

1.5, 2, 3, 4.5, 6, 8, 10 mm.

- Grates carrots and cabbage for raw salad.
- Grates nut, almonds and dry bread.

- Grates cheese for pizza and gratin.
- Shreds cabbage/white cabbage.

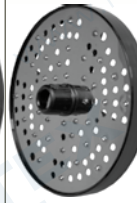

Fine Grater Extra Fine Grater Hard Cheese Grater

- Grates root vegetables, dry bread, cheese etc.
- Fine Grater grates raw potatoes for potato pancakes.

- Extra Fine Grater grates radish, dry bread, etc.
- Hard Cheese Grater is perfect for cheese such as parmesan.

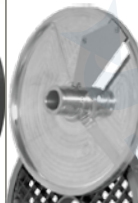

Soft Dicing

8, 10, 12, 15 mm.

- Combination to dice soft products like tomatoes, onion, pepper, bananas, kiwi, strawberries etc.



RG-50 Vegetable Preparation Machine

- Large half moon shaped feed cylinder that can take most items whole.
- Compact table top model that takes up little space but is in spite of its size a very flexible machine. RG-50 can do what HALLDE's larger machines do with the same good quality.
- Easy piling of tomatoes, onions, bell peppers etc. for oriented slicing.
- Self tensioning and geared belt driven motor gives a high torque.
- Machine base is completely in metal and holds for rough handling.

Machine

- Motor: 0.25 kW. One-speed. 120 V, single phase, 60 Hz.
220-240 V, single phase, 50-60 Hz.
- Transmission: Toothed belt.
- Safety system: Two safety switches.
- Degree of protection machine: IP34.
- Power supply socket: Earthed, single phase, 10 A.
- Fuse: 10 A, delayed action fuse.
- Sound level LpA (EN31201): 76 dBA.
- Magnetic field: Less than 15 microtesla.

Materials

- Machine housing: Anodized and polished aluminium alloy.
- Feed head: Polycarbonate and polyamide.
- Ejectory plate: Acetal.
- Cutting tool discs: Aluminium alloy or acetal.
- Cutting tool knife blades: Stainless knife steel.

Feeder

- Feed cylinder: Volume 0.9 litre.
Height 185 mm. Diameter 170 mm.
- Feed tube with internal diameter 53 mm.

Cutting tools

- Diameter: 185 mm.
- Speed: 400 rpm (50 Hz), 480 (60 Hz).

Type of preparation

- Slices, dices, shreds, grates, makes julienne and crimping slices.
- Processes fruit, vegetables, dry bread, cheese, nuts, mushrooms, etc.

Users

- For restaurants, pizzerias, salad bars, schools, day care centers, fast food counters, catering kitchens, etc.

Net weights

- Machine: 13 kg.
- Cutting plates: 0.5 kg.

Standards

- EU Directive 98/37/EEC, LVD 73/23 EEC, EMC 89/336/EEC. • NSF/ANSI Standard 8.

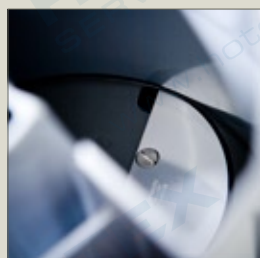
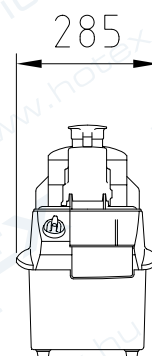
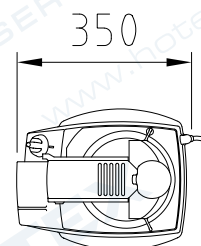
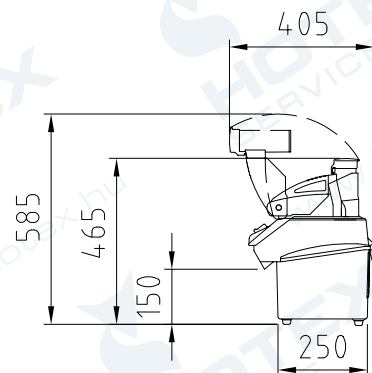

Food Preparation Machines
Made in Sweden



AB Hallde Maskiner P.O. Box 1165 SE-164 26 Kista Sweden
• Phone: +46 8 587 730 00 • Fax: +46 8 587 730 30 • www.hallde.com • info@hallde.com

