

- B 193
- B 350
- B 393**
- B 550
- RB 400
- BH 360
- BH 550
- BH 900
- B 1025
- B 120
- BH1100
- BH1300
- BH1600
- B 3200
- B 4600

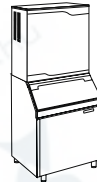

B393 with MV450  
(sold separately)



B393 with MV600  
(sold separately)

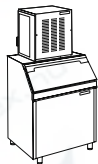

B393+KBT103 with NME654  
(sold separately)

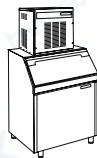

B393+KBT103 with MF30  
(sold separately)

B393+KBT103 with MF41  
(sold separately)

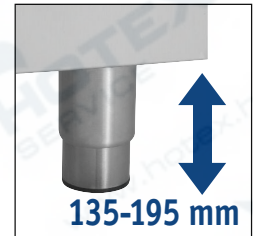

**Ice Storage  
Bin**



**Cabine  
de Stockage**

**Eisspeicher**

**Cabina  
Almacenadora**

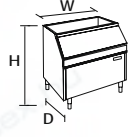
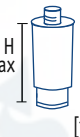

**Contentitore  
Ghiaccio**

	CUBE ICE (full Dice)			FLAKE ICE					
	[kg]	(lbs)	**N°	[kg]	(lbs)	[WxDxH mm]	[WxDxH inches]	[mm]	[inches]
B 393 S	150	330	9800	130	287	765 x 825 x 1095	30 2/16" x 32 6/16" x 43 2/16"	135-195	5 5/16"-7 11/16"

**Accessories:**

- KBT 103 Top insulated stainless steel Top provides cover for B 393 and base when mounting a modular flaker
- Caster Kit-KRB 550

\*\* Estimate

## 2

**Years Warranty  
Ans de Garantie  
Jahre Garantie  
Años de Garantía  
Anni di Garanzia**



Subject to certain limitations and exclusions  
Assujettie aux limites et exclusions prescrites  
Abhängig von Bestimmten Einschränkungen und Ausnahmen  
Sujeta a algunas limitaciones y exclusiones  
Soggetta ad alcune limitazioni ed esclusioni

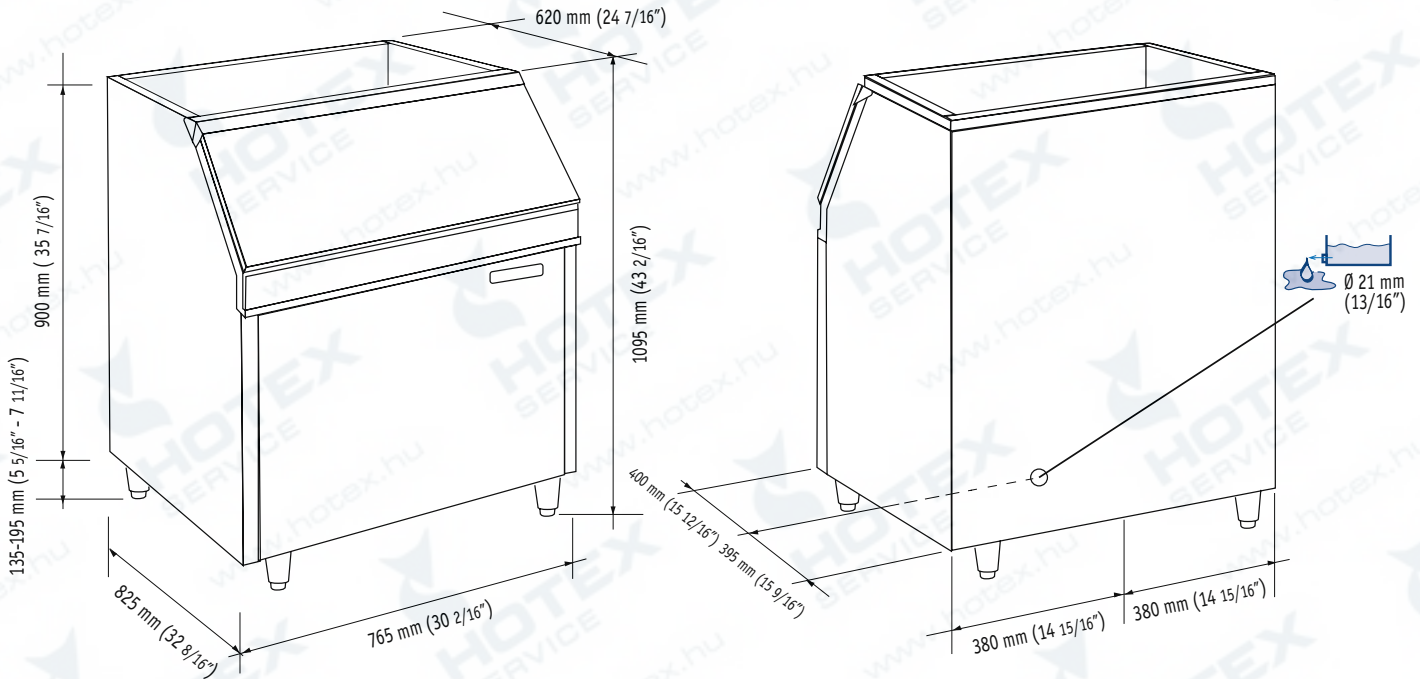

This product qualifies for the following listings:

# B 393



	 [kg]                      [lbs]		 [kg]                      [lbs]	
B 393 S	41	90	54	119

Thanks its vertical shape this ice bin fits into any environment. It is higher and narrower than most other bins with the same capacity. Ideal match for the MV 450 and 600, MF 30, FME 804, NME 654, MF 41. The liner is molded in one piece in sanitary ABS and is polyurethane foam insulated. The plastic door opens full width to allow easy access to the ice.

Le reserve de glace qui mieux s'adapte à n'importe quel type d'emplacement, vu sa structure à protection verticale: elle est, en effet bien plus haut et plus étroite que les autres cabinets, tout en ayant la même capacité. Complément idéal pour les machines MV 450 et 600, MF 30, FME 804, NME 654 et MF 41. Elle est constituée d'une seule moule en ABS atoxique pour aliments. La cellule est isolée par du polyurethane expansé. La porte d'accès, sur toute la largeur, est en matériel synthétique et permet un enlèvement aisé de la glace.

Dank seiner schlanken Ausrichtung integriert sich dieser Speichertyp in nahezu jede Umgebung problemlos. Er ist bei Fassungsvermögen höher und schmaler als der vergleichbare B393 Eisspeicher. Dieser Speicher gilt als ideal für MV450, MV600, MF30, MF41 und NME654. Die Speicherzelle ist aus lebensmittelechten ABS in einem Stück gegossen. Die verwendete Isolierung ist aus Polyurethan-Schaum gefertigt. Die aus Kunststoff gefertigte Entnahmeklappe erstreckt sich die gesamte Breite des Speichers und gewährleistet somit eine leichte Eisentnahme.

Presenta la mejor adaptabilidad a cualquier colocación, dada su estructura de proyección vertical. Además resulta más alto y más estrecho que otros contenedores de igual capacidad. Complemento ideal para los fabricantes de hielo en cubitos MV 450/600 y para los modelos MF 30, FME 804, NME 654 y MF 41, de hielo triturado. Provisto de cuba de una sola pieza, en ABS atóxico alimentario. El aislamiento de la misma es en poliuretano expandido. La puerta, de anchura total, está construida en material sintético y permite recoger el hielo cómodamente.

E' il contenitore di ghiaccio che presenta la migliore adattabilità a qualsiasi collocazione, data la sua struttura a proiezione verticale. Infatti risulta molto più alto e più stretto degli altri contenitori aventi la medesima capacità. Complemento ideale per i fabbricatori di ghiaccio a cubetti MV 450 e 600 e per MF 30, FME 804, NME 654, MF 41 è fornito di cella in unico stampo in ABS atossico per alimenti. La coibentazione della stessa è in poliuretano espanso. Lo sportello, a tutta larghezza, è costruito in materiale sintatico e consente un comodo prelievo del ghiaccio.



**Scotsman**® The one the world relies on.  
Ice Systems



**USA, Canada, Latin America**  
Scotsman Ice Systems USA  
775 Corporate Woods Parkway  
Vernon Hills, IL 60061  
Ph: (847) 215-4550  
Fax (847) 913-9844  
customerservice@scotsman-ice.com

**Europe**  
Scotsman Europe-Frimont S.p.A.  
Via Puccini, 22  
20010 Pogliano (Milano) Italy  
Ph: (+39) 02-93960208  
Fax: (+39) 02-93960201  
scotsman.europe@frimont.it

**Asia and Pacific**  
Scotsman Ice Systems-Frimont S.p.A. (R.O.)  
627A Aljunied Road-#04-04 Biztech Centre  
Singapore 389842  
Ph: (+65) 6738 5393  
Fax: (+65) 6738 1959  
scotsice@singnet.com.sg

**China**  
Scotsman Ice Systems  
258 Tong Ren Road Golden Tower 7A  
Shanghai-200040 Peoples's Republic of China  
Ph: (+86) 21-62476056  
Fax: (+86) 21-62476126  
scotsmansh@online.sh.cn

**Middle East & N. Africa**  
Scotsman Ice Systems Dubai Office  
P.o. Box 13205 - Deira  
Dubai - U.A.E.  
Ph: +9716-5654036  
Fax +9716-5654063  
scotsman@emirates.net.ae

**South Africa**  
Scotsman Ice Systems SA (PTY) Ltd.  
10, Rhodes Street - Kensington B  
P.o. Box 44 - Riverclub 2149  
Ph: +27-11-7898400  
Fax +27-11-7898411  
scotsman@telkomsa.net